



***PF2100 BMS MANUAL*** *REV 1.8*  
BURNER MANAGEMENT SYSTEM

## **WARNING**

**THIS EQUIPMENT IS SUITABLE FOR USE IN CLASS 1, DIVISION 2, GROUPS ABCD OR NON-HAZARDOUS LOCATIONS ONLY.**

WARNING: EXPLOSION HAZARD

DO NOT DISCONNECT WHILE CIRCUIT IS LIVE UNLESS AREA IS KNOWN TO BE NON-HAZARDOUS OR EQUIVALENT

WARNING: EXPLOSION HAZARD

SUBSTITUTION OF COMPONENTS MAY IMPAIR SUITABILITY FOR CLASS 1, DIVISION 2.

MUST CONFORM TO THE DIRECTIONS IN THIS MANUAL

THE UNIT MUST BE PROPERLY CONNECTED TO EARTH-GROUND FOR EFFECTIVE IONIZATION OPERATION

ELECTRICAL DEVICES CONNECTED TO THE CONTROLLER MUST MEET ELECTRICAL STANDARDS AND BE WITHIN VOLTAGE LIMITS

DO NOT SERVICE UNLESS AREA IS KNOWN TO BE NON-HAZARDOUS

DO NOT OPEN WHEN ENERGIZED

SUBSTITUTION OF COMPONENTS MAY IMPAIR THE SUITABILITY FOR USE IN CLASS 1, DIVISION 2

REPLACEMENT FUSES MUST BE CERAMIC

## **APPROVALS**

CSA 22.2 No. 199-2007

ANSI Z21.20-2007

UL1998-2004

Class 1, Division 2, Grp

ABCD

IEC Ex nA IIC

IP54

NEMA Type 4x

CSA C22.2 No. 0-M91

CSA C22.2 No. 0.4-04

CSA C22.2 No. 94-91

CSA C22.2 No. 142-M1987

CSA C22.2 No. 213-M1987

CSA E60079-0:2007

CSA E60079-15:2005

UL 508, 17th Edition

ANSI-ISA-12.12.01-2007

UL 60079-0:2005

UL 60079-15:2002



MC#248705

FOR ANY QUESTIONS PLEASE CALL

**1 855 PRO FIRE**  
(776-3473)



## **GENERAL FEATURES**

- Designed for the natural draft-fire, tube heater industry
- Meets or exceeds all relevant codes and standards
- Easy installation with clearly marked component I/O
- Easily accessible removable terminal connections
- Rapid 3 second shut-down on flame-out
- DC voltage spark ignition
- Low-power design to accommodate solar panel or TEG applications
- Auto-relight or manual operation
- Transient protected and fail-safe circuits

## **ENCLOSURE**

Polyester

309 x 234 x 134 mm (12.15" x 9.23" x 5.28")

overall dimensions 2.3 kg (5 lb)

CSA and UL compliant for Class 1, Division 2 locations

Enclosure type 4, 4X, 12, 13

## **CIRCUIT BOARDS**

All solid state

CSA compliant for Class 1, Division 2 locations

Certified for use on B.149 compliant valve trains

## **IGNITION BASE AND COIL**

For non-hazardous mounting area only

Ignition coil mounted in the 2100 is optionally available.

## **TEMPERATURE RATING**

-40°C to +55°C (Tested to -60°C)

-40°F to +130°F (Tested to -76°F)

## **INPUTS & OUTPUTS**

(6) Digital inputs for safety interlock device connections

(5) Digital outputs

(1) 4-20mA output

(1) Flame-rod input

(3) Thermocouple inputs

See Section 1.3 for thermocouple inputs

## **FUSE**

Only equivalent fuse should be used to replace a blown fuse.

Factory fuse: LittleFuse 0314005.HXP

(5A, 250V Ceramic, Fast Blow)

## **POWER REQUIREMENTS**

10VDC to 28VDC (voltage must match solenoid rating) 5A MAX

<b>POWER COMSUMPTION</b>	<b>12V</b>	<b>24V</b>	
Controller only, display ON	2.6 W	2.8 W	
Controller only, display OFF	1.1 W	1.4 W	





## 1.1 Mounting Locations

- The control panel can be mounted on the unit skid or on a building wall providing it does not infringe on a Class 1, Division 1 area.
- Use control panel mounting tabs to mount in a location that faces away from the burner housing so the operator is facing both the enclosure and the burner housing while operating. Other considerations may include panel access, traffic, wire-runs and visibility.
- The control panel should be mounted about 1.5m (5') above ground level.
- If an external ignition coil is used, it must be mounted in a Class 1, Division 2 enclosure or a non-hazardous location, ideally inside the burner housing.

## 1.2 P&ID and Wiring Diagram

Any design used, should be approved by a qualified inspector and approved by the gas authority having jurisdiction at the site where the system is to be installed.

Additional P&ID and wiring diagrams are provided in a separate application note.

# 1.3 P&ID and Wiring Diagram Examples

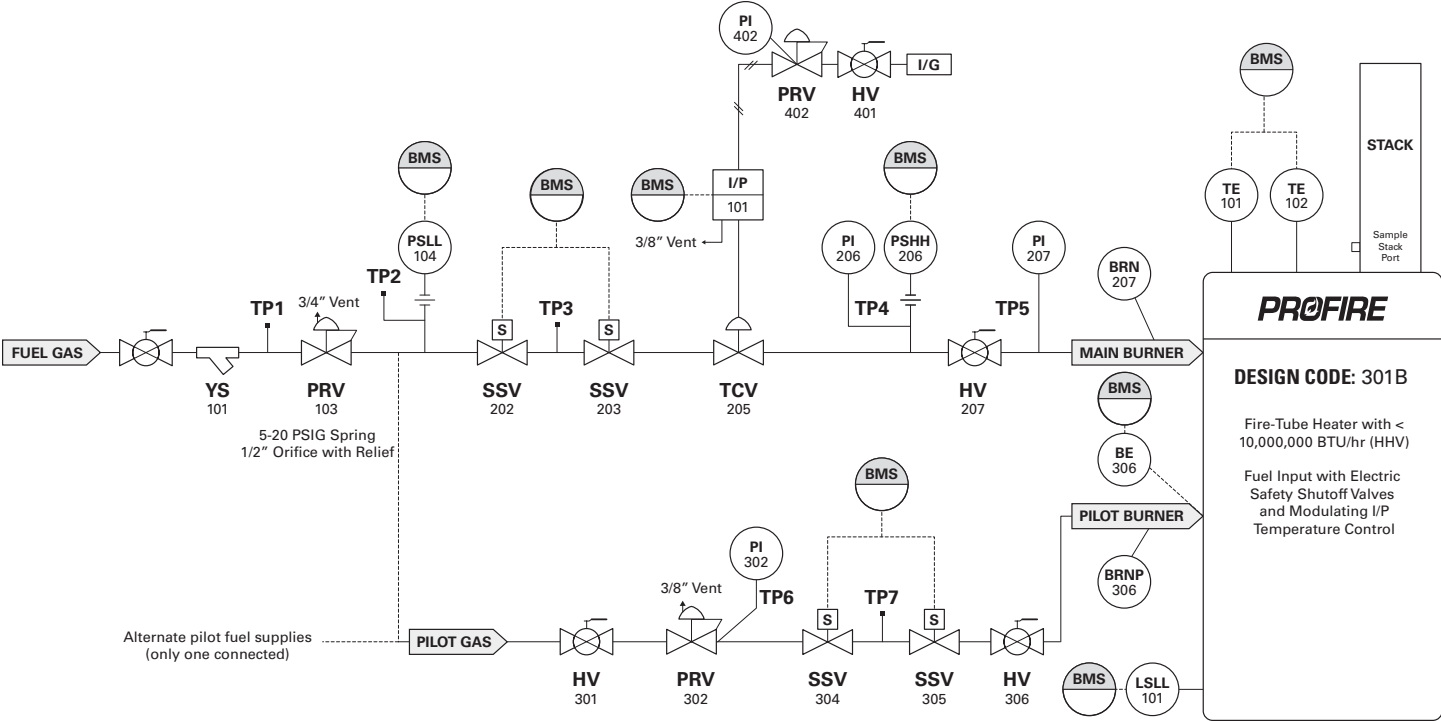

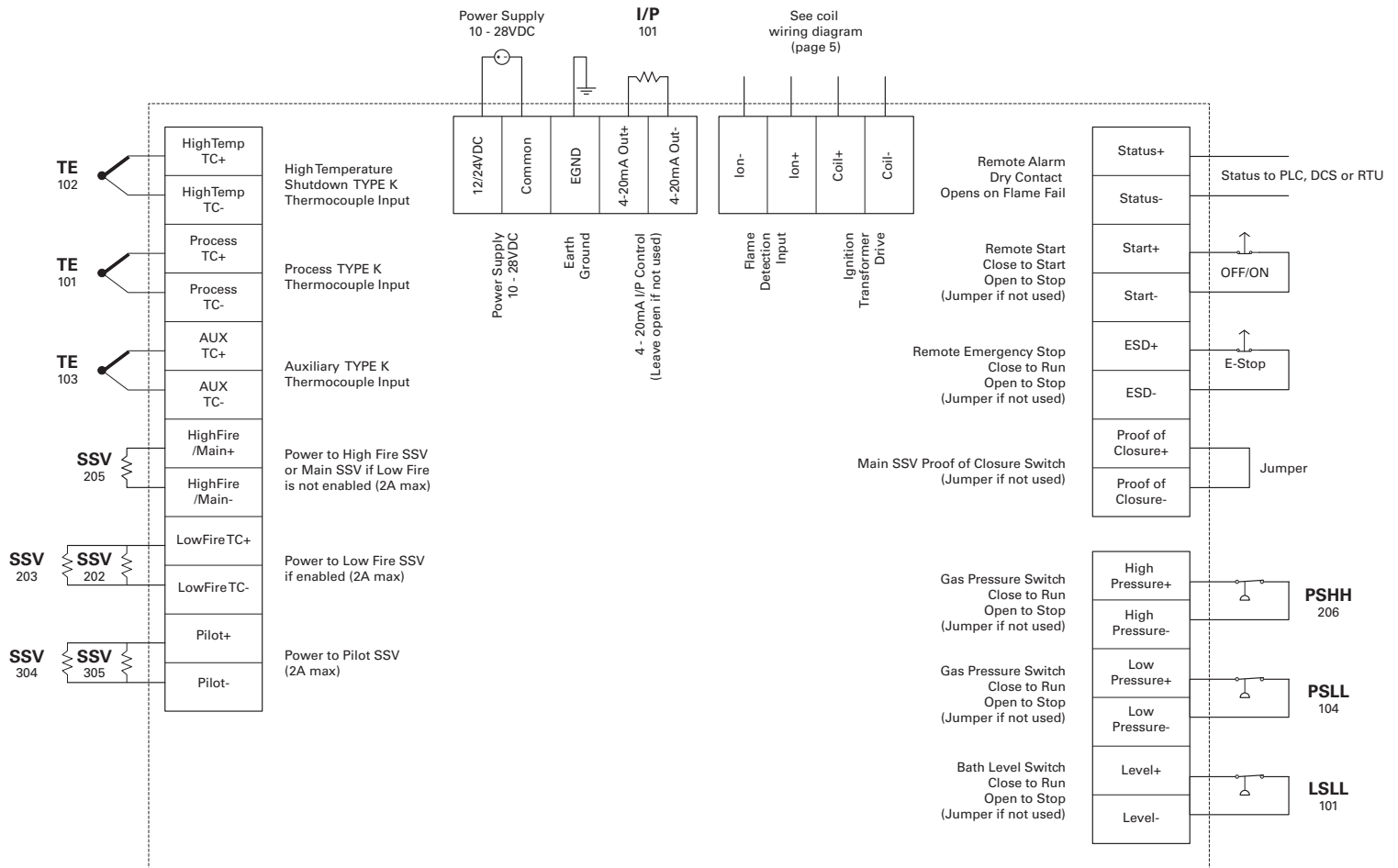

# 1.4.1 External Coil

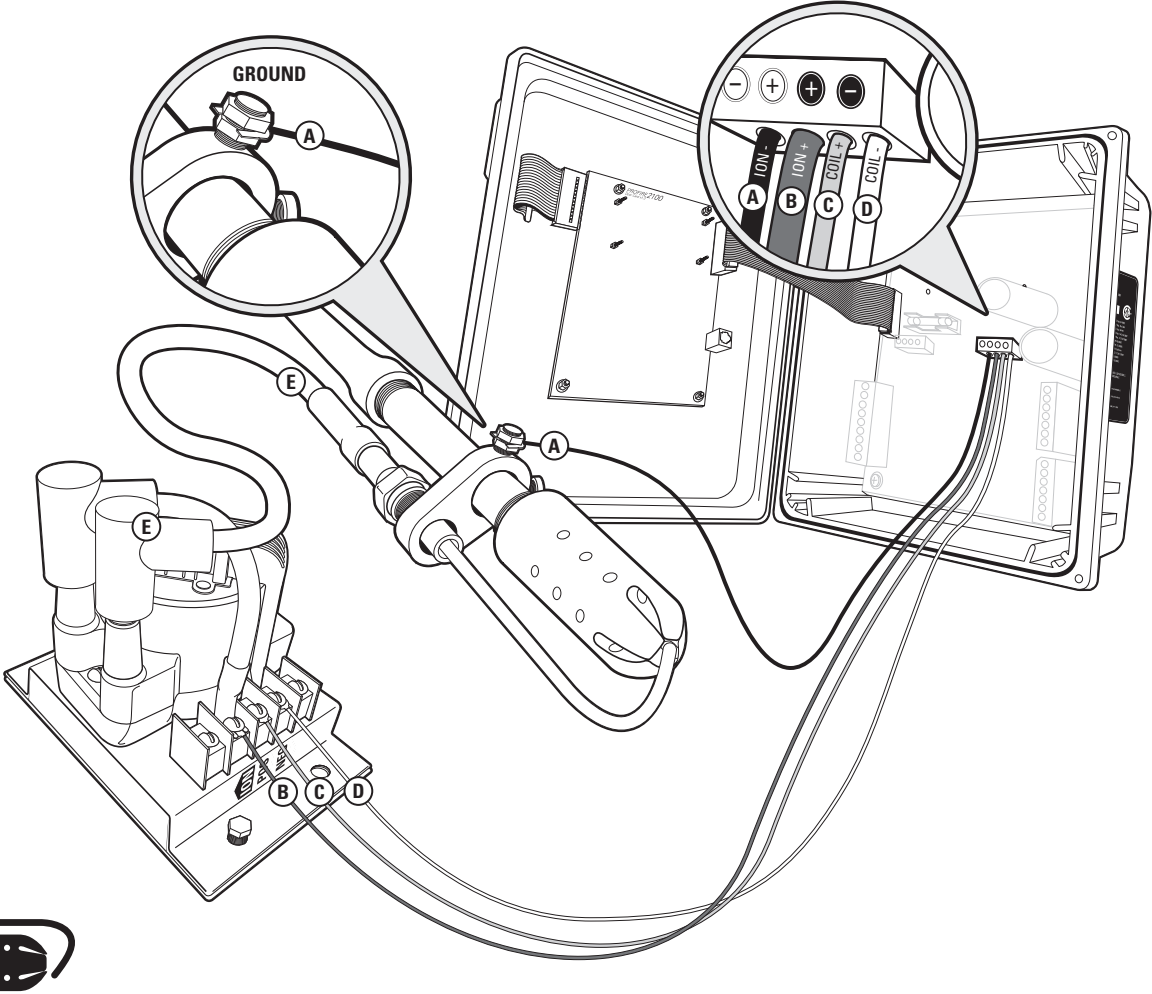

# 1.4.2 Internal Coil

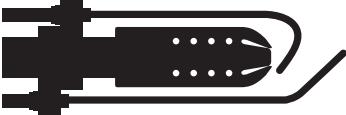
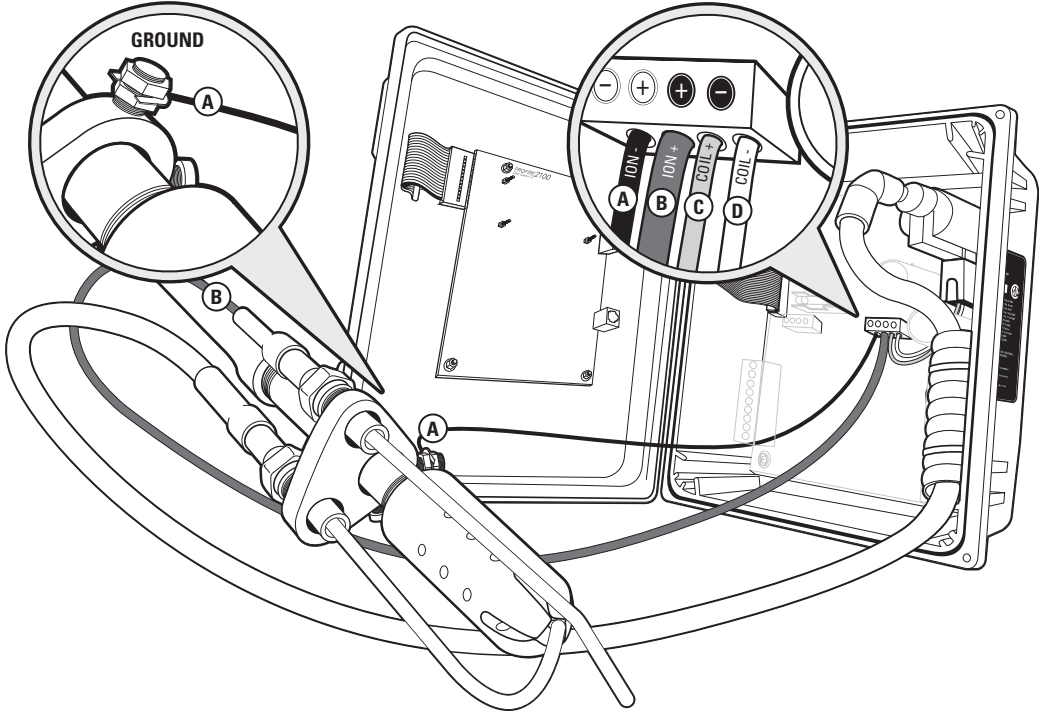

## 1.5 Terminal Description

CONNECTION	DESCRIPTION	EXPECTED CONNECTIONS	RATINGS
12/24VDC	Input power 10VDC-28VDC, 5A MAX	Input power from a DC source	10VDC - 28VDC Internally fused at 5A
Common	Common	Ground from DC source	Internally connected to EGND
EGND	Earth Ground	Earth or Chassis ground	Internally connected to Common
4-20mA Out +	4-20mA output intended to drive a proportional control valve. This output will be connected to a Current to Pressure converter which will drive a proportional control valve. A software control loop is implemented to tune the flame to match the demand. Proportional control is optional.	A resistance of 120Ω to 250Ω is expected.	
4-20mA Out -	Ground	Ground return for the 4-20mA output	
HighTemp_TC + (YELLOW)	Thermocouple input. High Temp shutdown thermocouple.	"TYPE K" thermocouple must be connected between the "+" and "-" terminals and must not be electrically connected to ground.	
HighTemp_TC - (RED)	Thermocouple Input. Negative terminal of High Temp Shutdown thermocouple.	An uninterrupted connection using "TYPE K" thermocouple wire is required for an accurate reading.	
Process_TC + (YELLOW)	Thermocouple input. Process thermocouple.	"TYPE K" thermocouple must be connected between the "+" and "-" terminals and must not be electrically connected to ground.	
Process_TC - (RED)	Thermocouple Input. Negative terminal of Process thermocouple.	An uninterrupted connection using "TYPE K" thermocouple wire is required for an accurate reading.	

1.5 Terminal Description Continued...

CONNECTION	DESCRIPTION	EXPECTED CONNECTIONS	RATINGS
AUX_TC + (YELLOW)	Thermocouple input. Auxiliary thermocouple. Optional use.	A "TYPE K" thermocouple must be connected between the "+" and "-" terminals and must not be electrically connected to ground.	
AUX_TC - (RED)	Thermocouple Input. Negative terminal of Auxiliary thermocouple.	An uninterrupted connection using "TYPE K" thermocouple wire is required for an accurate reading.	
High Fire/Main +	Positive terminal of the High Fire / Main valve	Solenoid valves must be connected between the "+" and "-" terminals. The negative terminal is not directly connected to ground so a common return wire for the High Fire, Low Fire and Pilot valves cannot be used.	Maximum continuous current is 2A. If "Low Power" mode is enabled, a peak load of 4A is permitted.
High Fire/Main -	Negative terminal of the High Fire / Main valve		
Low Fire +	Positive terminal of the Low Fire valve	Solenoid valves must be connected between the "+" and "-" terminals. The negative terminal is not directly connected to ground so a common return wire for the High Fire, Low Fire and Pilot valves cannot be used.	
Low Fire -	Negative terminal of the Low Fire valve		
Pilot +	Positive terminal of the Pilot valve	Solenoid valves must be connected between the "+" and "-" terminals. The negative terminal is not directly connected to ground so a common return wire for the High Fire, Low Fire and Pilot valves cannot be used.	
Pilot -	Negative terminal of the Pilot valve		
Ion +	Flame Detection Input. Connected to a Flame-rod.	A Kanthal rod should be placed directly in the pilot flame and connected to this input. The pilot assembly must be grounded for the flame detection to function properly. Input is protected from high voltage and can be connected in series with the high voltage terminals of an external ignition coil, allowing a single flame-rod to be used for both ignition and flame detection.	A 65VAC signal is applied to the flame rod. The source impedance is very high so there is no danger of sparking.
Ion -	Ground	Ground return for flame detection. Must be connected to the burner housing.	

1.5 Terminal Description Continued...

<b>CONNECTION</b>	<b>DESCRIPTION</b>	<b>EXPECTED CONNECTIONS</b>	<b>RATINGS</b>
Coil +	Driver for the low voltage primary of the ignition coil.	The primary of the ignition coil should be connected to this terminal. The 12/24VDC input power will be applied for 1 ms and turned off for 50 ms while sparking.	This output is protected by a 250mA thermal fuse.
Coil -	Ground	Ground return for the ignition coil.	
Status +	The status "+" and "-" contacts will be closed when the system is running and opened when the system is shutdown.	Dry contact output to indicate system status to an external device. ie. PLC.	250VAC/DC, 200mA, 15Ω
Status -			
Start +	Remote start input from an external device. ie. PLC.	Dry contact switch is expected. The input is internally pulled up to 9VDC via a 3.75kΩ resistance. Jumper "+" and "-" if not used.	
Start -	Ground	Ground return for switch. All switches can use a single common ground return.	
ESD +	External Shutdown input.	Dry contact switch is expected. The input is internally pulled up to 9VDC via a 3.75kΩ resistance. Jumper "+" and "-" if not used.	
ESD -	Ground	Ground return for switch. All switches can use a single common ground return.	
Proof of Closure +	Proof of Closure from main valve(s).	Dry contact switch is expected. The input is internally pulled up to 9VDC via a 3.75kΩ resistance. Jumper "+" and "-" if not used.	
Proof of Closure -	Ground	Ground return for switch. All switches can use a single common ground return.	
High Pressure +	Input from a mechanical pressure switch.	Dry contact switch is expected. The input is internally pulled up to 9VDC via a 3.75kΩ resistance. Jumper "+" and "-" if not used.	

1.5 Terminal Description Continued...

<b>CONNECTION</b>	<b>DESCRIPTION</b>	<b>EXPECTED CONNECTIONS</b>	<b>RATINGS</b>
High Pressure -	Ground	Ground return for switch. All switches can use a single common ground return.	
Low Pressure +	Input from a mechanical pressure switch.	Dry contact switch is expected. The input is internally pulled up to 9VDC via a 3.75kΩ resistance. Jumper "+" and "-" if not used.	
Low Pressure -	Ground	Ground return for switch. All switches can use a single common ground return.	
Level +	Input from a float-switch mounted in the bath.	Dry contact switch is expected. The input is internally pulled up to 9VDC via a 3.75kΩ resistance. Jumper "+" and "-" if not used.	
Level -	Ground	Ground return for switch. All switches can use a single common ground return.	

## 1.6 Thermocouples

ALL THERMOCOUPLES MUST BE ISOLATED FROM THE GROUND

### **PROCESS THERMOCOUPLE**

*"TYPE K"*

Primary temperature control device provides high-temp shutdown. 20 AWG or larger *"TYPE K"* extension wire must be used. System will shutdown if an open circuit or short circuit is detected. Should be placed in the same thermowell as *HIGH TEMPERATURE THERMOCOUPLE*.

### **HIGH TEMPERATURE THERMOCOUPLE**

*"TYPE K"*

Provides high-temp shutdown. 20 AWG or larger *"TYPE K"* extension wire must be used. System will shutdown if an open circuit, short-circuit or short-to-ground is detected. Should be placed in the same thermowell as *PROCESS THERMOCOUPLE*.

### **AUX THERMOCOUPLE**

*"TYPE K"*

Optional and can be enabled in the System Setup menu (**MENU 5**). Can be set up to monitor stack temperature or control a secondary process temperature. 20 AWG or larger *"TYPE K"* extension wire must be used. System will shutdown if an open circuit is detected and *AUX THERMOCOUPLE* is enabled.

- \* TE101 and TE102 may be different elements in the same head of a *"TYPE K"* thermocouple
- \* For all thermocouples, avoid locating extension wire near high-voltage lines. Shield if necessary.

## 2.1 Keypad Layout

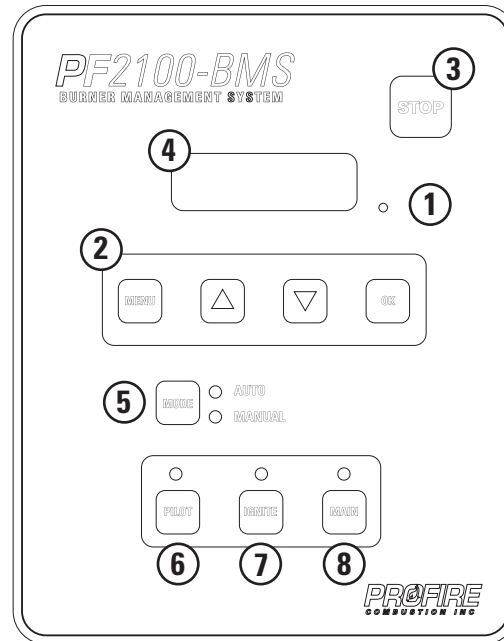

- 1** RUN LIGHT
- 2** MENU NAVIGATION
- 3** STOP BUTTON
- 4** DISPLAY WINDOW
- 5** MODE BUTTON
- 6** PILOT BUTTON
- 7** IGNITE BUTTON
- 8** MAIN BUTTON

## 2.2 Menu Operation

The system must be in manual mode in order to access the menus. Press the "MENU" button to step through the menus. When the desired menu is displayed, press the "OK" button to enter that menu. Once in the menu, the "MENU" button will step through the parameters.

While viewing the desired parameter use the  $\Delta$  and  $\nabla$  buttons to adjust the setting and "OK" to accept the change. To exit back to the "Ready" screen, press the "OK" button without making any changes. From the "Ready" screen, the  $\Delta$  and  $\nabla$  buttons will scroll through the current system status.

# 2.3 Menu Map

CYCLE THROUGH WITH MENU BUTTON, CONFIRMING WITH OK BUTTON

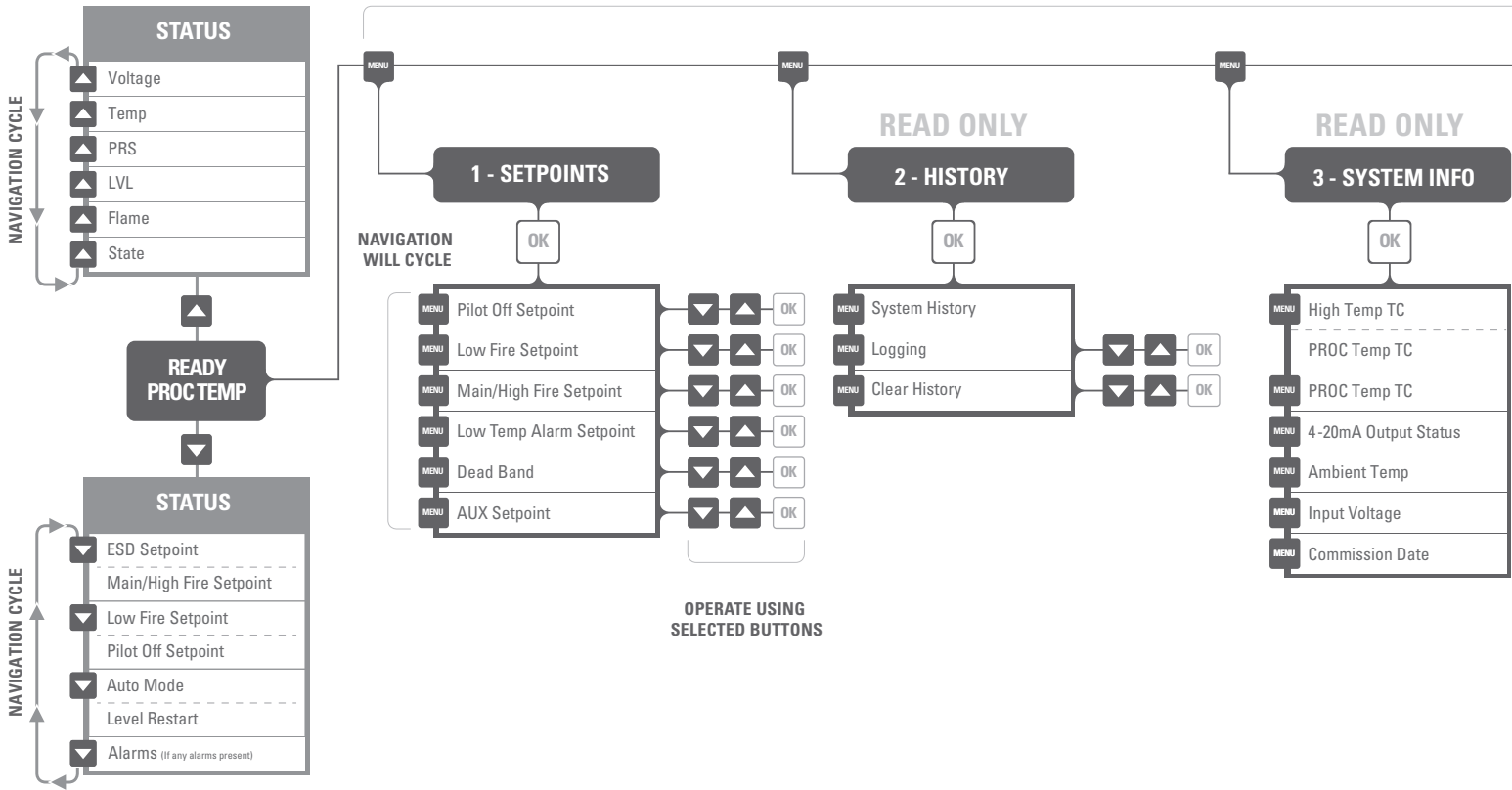

MENU

MENU

MENU

4-20 LEVEL AND PRESSURE MENU ITEMS  
WILL BE HIDDEN WHEN NOT ENABLED

### 4 - SYSTEM SETUP

### 5 - CONTROL SETUP

### 6-EXPANSION MODULES

OK

OK

OK

MENU	Auto Start Mode	▼	▲	OK
MENU	Purge Time	▼	▲	OK
MENU	Pilot to Main Delay	▼	▲	OK
MENU	Restart Attempts	▼	▲	OK
MENU	Level Event Restart	▼	▲	OK
MENU	Pressure/Level Delay	▼	▲	OK
MENU	Alarm Mode	▼	▲	OK
MENU	Password Enable (menus 1-3)	▼	▲	OK
MENU	Display Sleep	▼	▲	OK
MENU	Pilot Power Setting	▼	▲	OK
MENU	Main Power Setting	▼	▲	OK
MENU	System Voltage	▼	▲	OK
MENU	Temperature Display Units	▼	▲	OK
MENU	Commission Date Entry	▼	▲	OK
MENU	Commission Location Entry	▼	▲	OK
MENU	Reset to Factory Defaults	▼	▲	OK

MENU	High Temp ESD Setpoint	▼	▲	OK
MENU	Process Control	▼	▲	OK
MENU	Low Fire Enable	▼	▲	OK
MENU	Low to High Fire Delay	▼	▲	OK
MENU	Pilot Off Enable	▼	▲	OK
MENU	4 - 20 Output Mode	▼	▲	OK
MENU	4 - 20 Low Fire Setting	▼	▲	OK
MENU	4 - 20 Gain Setting	▼	▲	OK
MENU	AUX Thermocouple Type	▼	▲	OK

MENU	4-20 Input Card Enable	▼	▲	OK
MENU	4-20 Low Level	▼	▲	OK
MENU	4-20 High Level	▼	▲	OK
MENU	4-20 Max Volume	▼	▲	OK
MENU	4-20 Volume Units	▼	▲	OK
MENU	4-20 Level Span Calibration	▼	▲	OK
MENU	4-20 Level Zero Calibration	▼	▲	OK
MENU	4-20 Low Pressure Setpoint	▼	▲	OK
MENU	4-20 High Pressure Setpoint	▼	▲	OK
MENU	4-20 Max Pressure	▼	▲	OK
MENU	4-20 Pressure Units	▼	▲	OK
MENU	4-20 Pressure Span Calibration	▼	▲	OK
MENU	4-20 Pressure Zero Calibration	▼	▲	OK
MENU	MODBUS Enable/Address	▼	▲	OK
MENU	4-20 Cap	▼	▲	OK
	-----			
	MODBUS Card FW Version			

## 2.6.1 (MENU 1) Setpoints

Can only be accessed in manual mode. High Temp Setpoint is adjusted in MENU 5 - Control Setup (level 2 password)

ON SCREEN	DESCRIPTION	FUNCTION	RANGE	DEFAULT SETTING	USER SETTING
Pilot Off Setpoint: x°C (x°F)	Adjusts the temperature at which the Pilot valve will turn off.	When the Process temperature rises above this setpoint, the Pilot valve will close.  When the temperature drops below the High Fire/Temp setpoint minus the deadband, the Pilot will be re-ignited and the Low Fire valve will open (if enabled) followed by the High Fire/Main valve.	0 to 1350°C (32 to 2462°F)	60°C (140°F)	
LoFire Setpoint: x°C (x°F)	Adjusts the temperature at which the Low Fire valve will turn off.  <i>Disabled by default</i>	When the Process temperature rises above this setpoint, the Low Fire valve will close.  When the temperature drops below the High Fire setpoint minus the deadband, the Low Fire valve will open followed by the High Fire valve.	0 to 1350°C (32 to 2462°F)	55°C (131°F)	
Main/HighFire Setpoint: x°C (x°F)	Main process temperature setpoint. Adjusts the temperature at which the High Fire/Main valve will turn off.	<b>If Low Fire is Disabled</b> When the Process temperature rises above this setpoint, the main valve will close. <b>If Low Fire is Enabled</b> When the Process temperature rises above this setpoint, the High Fire valve will close.  The High Fire/Main valve will re-open when the temperature drops below this setpoint minus the deadband.	0 to 1350°C (32 to 2462°F)	50°C (122°F)	

### 2.6.1 (MENU 1) Setpoints Continued...

ON SCREEN	DESCRIPTION	FUNCTION	RANGE	DEFAULT SETTING	USER SETTING
Low Alarm Setpoint: x°C (x°F)	Adjust the Low Temperature Alarm setpoint  <i>Disabled by default</i>	If the Process temperature is below this setpoint, the status contacts will open but the system will remain running.	0 to 1350°C (32 to 2462°F)	DIS	
Dead Band: x°C (x°F)	Adjusts the Dead Band  <i>Disabled by default</i>	The temperature buffer below the High Fire/Temp setpoint	0 to 3°C (0 to 13°F)	2°C (11°F)	
AUX Setpoint: x°C (x°F)	Adjusts the Auxiliary setpoint.  <i>Disabled by default</i>	See section 2.6.5 (page 25) AUX TC Type	0 to 1350°C (32 to 2462°F)	20°C (68°F)	

## 2.6.2 (MENU 2) History

No adjustments are available in the History menu; the items are display only. Hold  $\Delta$   $\nabla$  + **OK** to reset history.

ON SCREEN	DESCRIPTION	FUNCTION	RANGE	DEFAULT SETTING	USER SETTING
ReLight = x	Displays the number of relights	Incremented when an automatic ignition attempt is made.	0 to 1000	0	
FlmFails = x	Displays the number of flame fails	When all retries attempts have failed, the unit shuts down and increments the Flame Fail counter	0 to 1000	0	
Resets = x	Displays the number of resets.	This number will increment every time the board is reset by a power loss or by pressing the reset button	0 to 1000	0	

2.6.2 (MENU 2) History Continued...

<b>ON SCREEN</b>	<b>DESCRIPTION</b>	<b>FUNCTION</b>	<b>RANGE</b>	<b>DEFAULT SETTING</b>	<b>USER SETTING</b>	
ESDs = x	Displays the total number of ESDs	This number will increment any time a fault causes the system to shutdown.	0 to 1000	0		
HPR ESDs = x	Displays the total number of High Pressure ESDs	This number will increment any time the system is shutdown due to High Pressure contact opening.	0 to 1000	0		
LPR ESDs = x	Displays the total number of Low Pressure ESDs	This number will increment any time the system is shutdown due to Low Pressure contact opening.	0 to 1000	0		
LVL ESDs = x	Displays the total number of Level ESDs	This number will increment any time the system is shutdown due to Level contact opening.	0 to 1000	0		
Open TC = x	Displays the total number of Thermocouple ESDs	This number will increment any time the system is shutdown due to a thermocouple fault.	0 to 1000	0		
TERMCARD = x	Displays the total number of Terminal Card ESDs	This number will increment any time the system is shutdown due to a fault from the Terminal Card.	0 to 1000	0		
Sys ERR = x	Displays the total number of System Error ESDs	This number will increment any time the system is shutdown due to a communication failure between the Door and Terminal Cards.	0 to 1000	0		

### 2.6.2 (MENU 2) History Continued...

<b>ON SCREEN</b>	<b>DESCRIPTION</b>	<b>FUNCTION</b>	<b>RANGE</b>	<b>DEFAULT SETTING</b>	<b>USER SETTING</b>	
Logging	Event Log	This is a log of recent events. Press OK to enter the log and use the up and down keys to navigate through the log. Press OK again to exit.	N/A	N/A		
Clear History? NO	Clear all History and logged events	To clear the history and log press and hold Up, Down, OK and Menu for 5 seconds To clear all history and log info to 0, change to YES and press OK.	YES/NO	NO		

### 2.6.3 (MENU 3) System Info

No adjustments are available in the System Info menu; the items are display only.

<b>ON SCREEN</b>	<b>DESCRIPTION</b>	<b>FUNCTION</b>	<b>RANGE</b>	<b>DEFAULT SETTING</b>	<b>USER SETTING</b>	
High Temp: x°C (x°F)	Thermocouple reading	Current temperatures read by the "High Temp" thermocouple	-50°C to 1350°C			
Proc Temp: x°C (x°F)	Thermocouple reading	Current temperatures read by the "Process" thermocouple	-50°C to 1350°C			
4-20mA Output x%	Current status of the 4-20mA Output	0% = 4mA 100% = 20mA	N/A	N/A		

2.6.3 (MENU 3) System Info Continued...

<b>ON SCREEN</b>	<b>DESCRIPTION</b>	<b>FUNCTION</b>	<b>RANGE</b>	<b>DEFAULT SETTING</b>	<b>USER SETTING</b>
Ambient Temp: x°C (x°F)	Displays the ambient temperature	This is the ambient temperature sampled on the board at the point where the thermocouples connect and is used for cold junction compensation of the thermocouples	-55°C to 65°C (-70°F to 150°F)	N/A	
System Voltage xx.x V	Displays the voltage applied to the system	Measures the input voltage to the system.	8V to 35V	N/A	
Commission Date: 01-JAN-2010	Date that the system was commissioned (if entered by user)	Data entry is done in menu 4.	DD-MON- YYYY	01-JAN-2010	
Location:	Displays the installed location of the system (if entered by user)	Data entry is done in menu 4.	N/A	N/A	

## 2.6.4 (MENU 4) System Setup

This menu always is password protected. The password is  $\triangle \nabla \triangle \triangle \nabla \triangle$  **OK** Cannot be accessed while BMS is running.

ON SCREEN	DESCRIPTION	FUNCTION	RANGE	DEFAULT SETTING	USER SETTING
Restore Factory Defaults = NO	Restore all settings to the factory default	All parameters will be reset to the default settings.	YES or NO	NO	
Auto Mode: OFF	Enables unit to recover from a power cycle, low pressure or high voltage event.	ON= Remain in auto mode after and restart after a power cycle, low pressure, low voltage or high voltage even. OFF = Unit will switch to manual mode and shutdown after a power cycle, low pressure, low voltage or high voltage event	ON or OFF	Off	
Purge Time: x Sec	Purge time	Time in seconds set for purge.	10 - 900	30	
Pilot to Main Delay: x Sec	Time from pilot proven to main enable	This is the number of seconds that the system will wait after the pilot has been proven until the main is opened.	5 - 600	15	
Restart Attempts: x	Restart attempts	Number of times the unit will try to light the pilot before alarming.  <b>NOTE:</b> The system will always try to ignite the pilot 3 times on initial ignition, this setting only applies to a flame out.	0 - 3	3	
Level Event Restart: OFF	Enables recovery from a Level event.	ON = Remain in auto mode and restart after a Level event. OFF = Unit will switch to manual mode and shutdown after a Level event.	ON or OFF	OFF	
PRS/LVL Delay: OFF	Pressure and Level shutdown delay.	When enabled, the system will delay 20 seconds for a level shutdown and 6 seconds for a pressure shutdown.	ON or OFF	OFF	

2.6.4 (MENU 4) System Setup Continued...

ON SCREEN	DESCRIPTION	FUNCTION	RANGE	DEFAULT SETTING	USER SETTING
Alarm Mode: No Alm when OFF	Status contact operation	<b>Alarm When OFF :</b> The status contacts will open when the unit is remote stopped. <b>No Alarm When OFF :</b> The status contacts will remain closed when the unit is remote stopped.	Alarm When Off or No Alm When OFF	No Alm When OFF	
Password: OFF	Password - when ON Menu 1, 2 and 3 become password protected.  <b>NOTE:</b> Menu 4, 5 and 6 are always password protected	ON = Menu 1,2,3 access restricted OFF = Menu 1.2.3 access open  The Level 1 password is △ ▽ △ △	ON or OFF	OFF	
Display Sleep, Never	Sleep Mode for the Display	Allows the Display to turn off after 10 min to save power.	Never / after 10 min	Never	
Pilot Solenoid PWM: 60%	Enables the Low Power mode for the Pilot solenoid	Indicates the percentage of ON time for the solenoid drive circuits. 20% is the lowest power setting.	OFF, 80%, 60%, 40%, 20%	60%	
Main Solenoid PWM: 60%	Enables the Low Power mode for the Main solenoid	Indicates the percentage of ON time for the solenoid drive circuits. 20% is the lowest power setting.	OFF, 80%, 60%, 40%, 20%	60%	
System Voltage: 12V	Configures the expected input voltage for the system	Used by the system to determine the over and under voltage lockout points. At 12V the valid input range is 9.5V to 17V. At 24V the valid input range is 19V to 34V.	12V or 24V	12V	
Temp Display: Celsius	Configures the temperature units used by the system	All display temperatures will be converted to the chosen unit.	Fahrenheit or Celsius	Celsius	
Commission Date: 01-JAN-2010	Date that the system was commissioned	This is a user modified parameter.	DD-MON- YYYY	01-JAN-2010	

## 2.6.4 (MENU 4) System Setup Continued...

ON SCREEN	DESCRIPTION	FUNCTION	RANGE	DEFAULT SETTING	USER SETTING
Commission Loc:	Displays the installed location of the system	This is a user modified parameter.		N/A	

## 2.6.5 (MENU 5) Control Setup

This menu always is password protected. The password is  $\triangle \nabla \triangle \triangle \nabla \triangle$   **OK** Cannot be accessed while BMS is running.

ON SCREEN	DESCRIPTION	FUNCTION	RANGE	DEFAULT SETTING	USER SETTING
High Temp ESD Setpoint: x°C	Adjusts the High Temperature shutdown setpoint	If process temperature reaches this setpoint, the system will shutdown and alarm.	0 to 1350°C (32 to 2462°F)	65°C (149°F)	
Process Control: Process Temp	Defines the source of the Process Temperature Control	<p><b>This can be set to</b></p> <p><b>Process Temp:</b> The Process Thermocouple is the primary temperature control device. The High Fire, Low Fire and Pilot Off setpoints apply to the Process Thermocouple.</p> <p><b>DISABLED:</b> The High Fire, Low Fire and Pilot Off setpoints will be disabled. The AUX Thermocouple can still be used for temperature control. ProH ESD setpoint will still be applied to the Process and High Temp thermocouples.</p> <p><b>AUXTemp:</b> The AUX Thermocouple is the primary temperature control device. ProH ESD setpoint will still apply to the Process and High Temp thermocouples.</p>	Enabled/ Disabled / AUX	Enabled	

2.6.5 (MENU 5) Control Setup Continued...

ON SCREEN	DESCRIPTION	FUNCTION	RANGE	DEFAULT SETTING	USER SETTING
Low Fire DISABLED	Low Fire Control	This will enable/disable the Low Fire output and Setpoint. The Low Fire output can be set to turn on at the High Fire or Low Fire Setpoint.	Disabled/ ON at High Fire Setpoint/ OFF at Low Fire Setpoint	Disabled	
LO to HI FIRE Delay: 30 Sec	Low Fire and High Fire delay	This is the number of seconds that the system will wait after the Low Fire valve is opened, before High Fire valve is opened.	30 - 600	30	
Pilot Off: ENABLED	Pilot Control	If enabled, the Pilot will turn off when the process temperature rises to the Pilot OFF Setpoint.	Disabled / Enabled	Enabled	
4-20 Output Mode: Valve Control	4-20 Output Selection	<b>VALVE CONTROL:</b> The 4-20 output will be configured to control a proportional valve based on the process temperature. <b>TEMPERATURE OUT:</b> The 4-20 output will be configured to echo the process temperature to a PLC 4mA = 0°C, 200mA = Proch ESD SETPOINT	Valve Control/ Tempera- ture Out	Valve Control	
4-20 Out Low Fire Setting: x%	Low Fire setting for main valve	This sets the minimum output for the 4-20mA driver.	0 to 60%	40%	
4-20p Gain: x.x%/Sec	Control loop gain	This sets the adjustment speed of the control loop for the 4-20mA driver.	0.1 to 1%	0.5%	

2.6.5 (MENU 5) Control Setup Continued...

ON SCREEN	DESCRIPTION	FUNCTION	RANGE	DEFAULT SETTING	USER SETTING
AUX TC Mode: Disabled	Auxiliary Thermocouple input configuration	<p><b>AUX thermocouple can be setup to DISABLED DISPLAY ONLY</b></p> <p>Not used for any temperature control or shutdown. The reading can be displayed or, using an expansion card, it can be logged or read remotely.</p> <p><b>PROCESS CONTROL</b></p> <p>In this mode the AUX Setpoint will work in conjunction with the High Fire/Temp Setpoint. If the AUX temp is below the AUX setpoint and the Process temp is below the High Fire/Temp Setpoint, the burner will be turned on. If either temperature crosses its setpoint, the burner will be turned off or switched to Low Fire depending on the setup.</p> <p><b>TEMP ESD</b></p> <p>The AUX setpoint will act like a second High Temperature ESD. If the AUX temperature crosses this setpoint, the system will shutdown and alarm.</p>	Disabled, Display Only, Process Control, Temp ESD	Disabled	

## 2.6.6 (MENU 6) Expansion Modules

ON SCREEN	DESCRIPTION	FUNCTION	RANGE	DEFAULT SETTING	USER SETTING
4-20 Input Card Enabled: No	Enable Control for 4-20 Expansion	When set to Yes the PF2100 will look for the 4-20 Expansion card. Shut-downs based on the card inputs will be enabled. If the card is not present and this setting is Yes the system will shutdown.	No/Yes	No	
4-20 Low Level Setpoint: 60 m3	Low level trip point	If the input to the 4-20 expansion is below this setting the system will shutdown.	0-Max Volume	60	
4-20 High Level Setpoint: 117 m3	High level trip point	If the input to the 4-20 expansion is above this setting the dry contact output on the 4-20 module will be in the fault state.	0-Max Volume	117	
4-20 Max Volume: 120 m3	Volume setting for the tank	This setting should be set to the maximum volume of the tank being measured.	0-10000	120	
4-20 Volume Units: m3	Display units	This setting adjusts the units displayed on the screen. No conversion math is performed.	%, m3, BBL, GAL, LTR	m3	
4-20 Level Span Calibration: No	20mA Calibration for the Level Input	To Calibrate the span of the 4-20 Level input apply a 20mA signal to the Level input, select Yes and press OK. The display should say Parameter Saved and then revert to No	No/Yes	No	
4-20 Level Zero Calibration: No	4mA Calibration for the Level Input	To Calibrate the span of the 4-20 Level input apply a 4mA signal to the Level input, select Yes and press OK. The display should say Parameter Saved and then revert to No	No/Yes	No	

2.6.6 (MENU 6) Expansion Modules Continued...

<b>ON SCREEN</b>	<b>DESCRIPTION</b>	<b>FUNCTION</b>	<b>RANGE</b>	<b>DEFAULT SETTING</b>	<b>USER SETTING</b>
4-20 Low PRS Setpnt: 3 PSI	Low Pressure Trip Point	If the input to the Pressure input of the 4-20 expansion module is below this setting the system will shutdown. If Auto Mode = Yes the system will restart when the pressure rises back above this setting.	0-High Setpoint	3 PSI	
4-20 High PRS Setpnt: 20 PS	High Pressure Trip Point	If the input to the Pressure input of the 4-20 expansion module is above this setting the system will shutdown.	Low set- point – Max Pressure	20 PSI	
4-20 Max PRS: 30 PSI	Maximum pressure setting	Should be set to the maximum pressure of the pressure transmitter being used.	0-2000	30 PSI	
4-20 PRS Units PSI	Defines the units for the pressure readout	Adjusts the units displayed on the screen. No conversion math is performed.	PSI, kPa	PSI	
4-20 PRS Span Calibration: No	20mA Calibration for the Pressure Input	To calibrate the span of the 4-20 pressure input, apply a 20mA signal to the pressure input, select Yes and press OK. The display should say parameter saved and then revert to No	No/Yes	No	
4-20 PRS Zero Calibration: No	4mA Calibration for the Pressure Input	To calibrate the zero of the 4-20 pressure input, apply a 4mA signal to the pressure input, select Yes and press OK. The display should say parameter saved and then revert to No	No/Yes	No	
MBUS Card: Disabled	Enable control and address for the Modbus Module	To enable the Modbus card press the up button to select the desired Modbus address	Disabled, 1-128	Disabled	



## 3.1 Typical Startup

*The operation sequence is as follows:*

1. Ensure system is installed correctly and all components are functioning properly.
2. Open manual valves.
3. Turn system run switch to "ON" (not part of unit).
4. The purge cycle begins. The programmed purge time is started when power is applied, or the main valve is off and no flame is detected.
5. The ignition cycle begins. The pilot solenoid is opened and ignition is turned on for a 10 second trial period. If the flame is seen, the flame indicator turns on and the main valve is opened. If the flame is not seen after this trial period, the pilot will turn off.
6. Check main valve indicator light to ensure valve is open.

## 3.2 Resets

- When the unit faults out, normally because an unsafe condition was detected, a reset is required.
- Before the unit can be reset, the condition causing the fault needs to be corrected. Some of the conditions that require a reset are:
  - o Stop button pressed
  - o Power supplied to the solenoids from an external source
  - o Gas pressure out of range
  - o Thermocouple wiring loose
  - o Flame-out
  - o Proof-of-closure switch not made before main solenoid energized
- A reset can be done locally or remotely.
- A local reset can be done by pressing the OK button on the front of the unit. Then the unit will need to be put back into AUTO mode by locally pressing the MODE button on the front of the unit.
- A remote reset is done by opening and then closing the Start contacts. A second open/close action of the Start contacts is required to start the unit.

### 3.3 Operational Description

On the Profire 2100 the pilot quality is monitored by a rectification circuit. When the pilot quality gets above the minimum acceptable (50%) the STATUS contact will close to indicate that the system is running.

#### TEMPERATURE CONTROL OPERATION

The Profire 2100 can be operated in various configurations. In all configurations, the pilot control output and spark ignition are used. However, control of the main valve and temperature control varies, depending on the installation and unit settings.

The unit has both "Low Fire" and "High Fire" outputs. The "Low Fire" is designed for establishing a draft in larger burners. Once the exhaust flow has stabilized, the "High Fire" valve opens. With temperature control, the "Low Fire" can also be used to regulate the process temperature. The unit also has a variable 4-20 mA output for controlling a proportional valve. When using variable 4-20 mA control, there is a "Low Fire" setting for the 4-20 mA output so the burner always starts with a preset "Low Fire" setting.

The Profire 2100 also has process high temperature monitoring. If the process temperature increases above the High Temp ESD setpoint, the unit will shut down by closing the main and pilot valves and then waiting for operator intervention. The Process High Shutdown is a dual system monitored by each microprocessor for redundant safety.

The Process Temperature control thermocouple can be enabled and used for temperature control. There are various methods that can be used for temperature control starting with a simple on/off control of the main valve to a variable control valve using the 4 - 20 mA control output signal.

### 3.4.1 Pilot and Main

If the process temperature setpoint is exceeded, the main valve closes until the temperature falls below the setpoint minus the dead band setting.

In this configuration, the low fire, and option to turn the pilot off, are disabled. This setup fires the main fully until the thermocouple reading exceeds “High Fire” setpoint.

<b>EXAMPLE SETTINGS</b>	<b>°C</b>	<b>°F</b>
High Fire Setpoint	50	122
Low Fire Setpoint	DIS	DIS
Pilot Off Setpoint	DIS	DIS
Process High ESD Setpoint	100	212
Low Alarm Setpoint	10	50
Dead Band	4	7

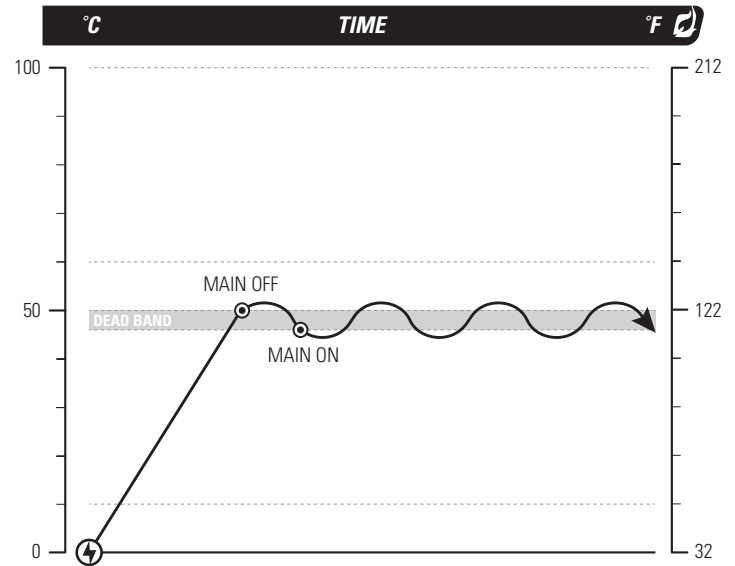
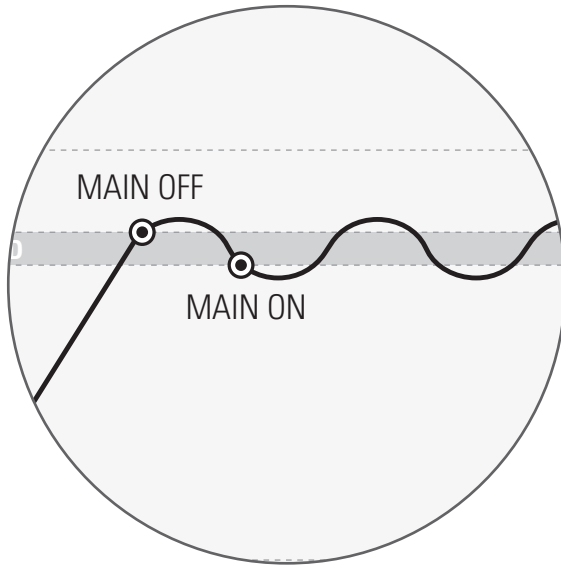

### 3.4.2 High Temperature Emergency Shutdown

This particular graph is a representation of the a “High Temperature Shutdown.” As shown, the ‘Pilot Off’ is enabled, which is showing that there is no heat being applied to the firetube, yet the temperature continues to increase.

Once the High Temp has been reached, the system will shut down and require user input to acknowledge the error.

EXAMPLE SETTINGS	°C	°F
High Fire Setpoint	50	122
Low Fire Setpoint	60	140
Pilot Off Setpoint	70	158
Process High ESD Setpoint	100	212
Low Alarm Setpoint	10	50
Dead Band	4	7

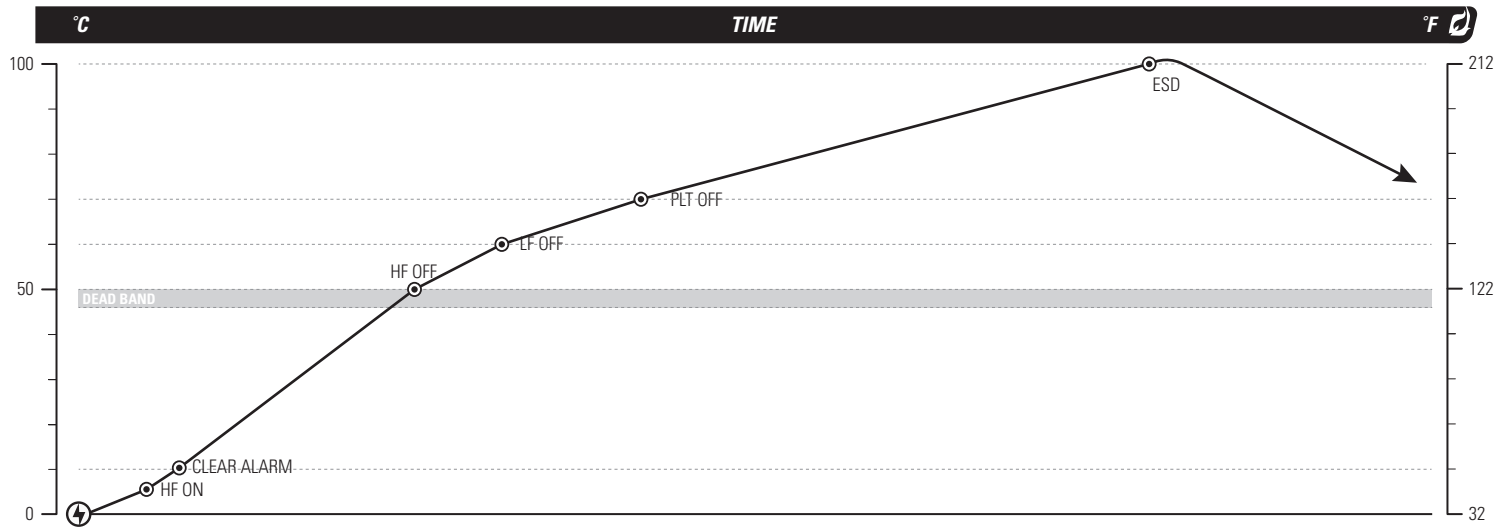

### 3.4.3 High Fire / Low Fire Control

All main valves are opened when the temperature is below the “High Fire” setpoint. When the temperature exceeds this setpoint, the High Fire valve closes until the temperature drops below the High Fire setpoint minus the dead band setting.

If the temperature continues to rise and exceeds the “Low Fire” setpoint, the Low Fire valve will close. The Low Fire will not open until the temperature goes below the High Fire setpoint minus the dead band.

EXAMPLE SETTINGS	°C	°F
High Fire Setpoint	50	122
Low Fire Setpoint	55	131
Pilot Off Setpoint	DIS	DIS
Process High ESD Setpoint	100	212
Low Alarm Setpoint	10	50
Dead Band	4	7

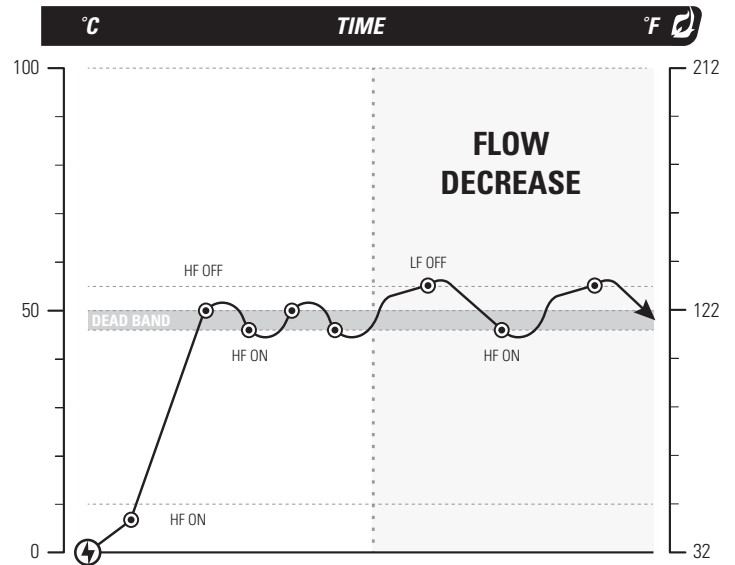
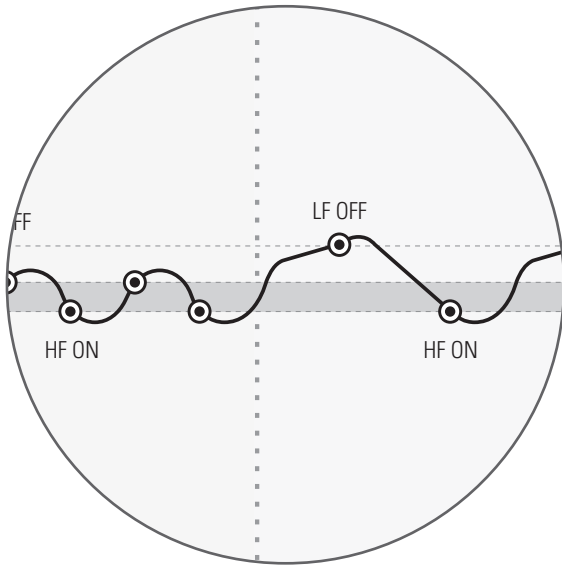

### 3.4.4 High / Low Fire with Pilot Off Control

The operation is the same as the High Fire / Low Fire Control but there is an additional "Pilot Off" setpoint above the "Low Fire" setpoint which will shut off the pilot. The unit will not re-light until the temperature is below the "High Fire" setpoint minus the dead band.

EXAMPLE SETTINGS	°C	°F
High Fire Setpoint	50	122
Low Fire Setpoint	DIS	DIS
Pilot Off Setpoint	60	140
Process High ESD Setpoint	100	212
Low Alarm Setpoint	10	50
Dead Band	4	7

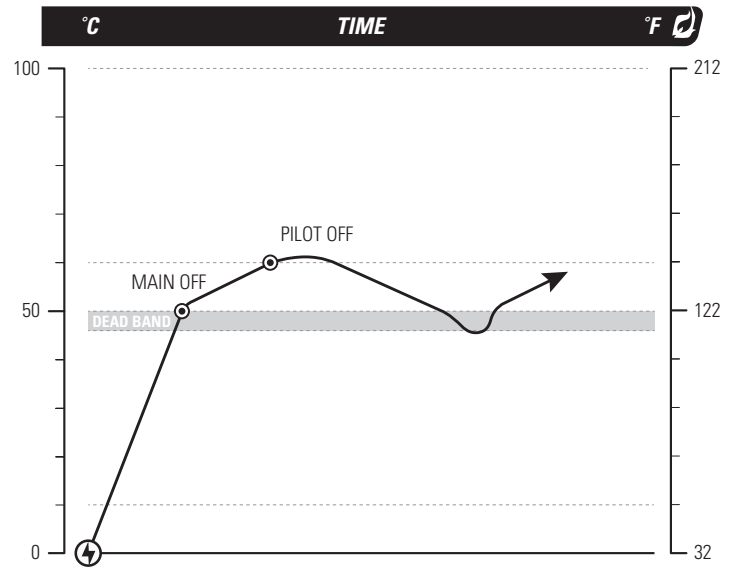
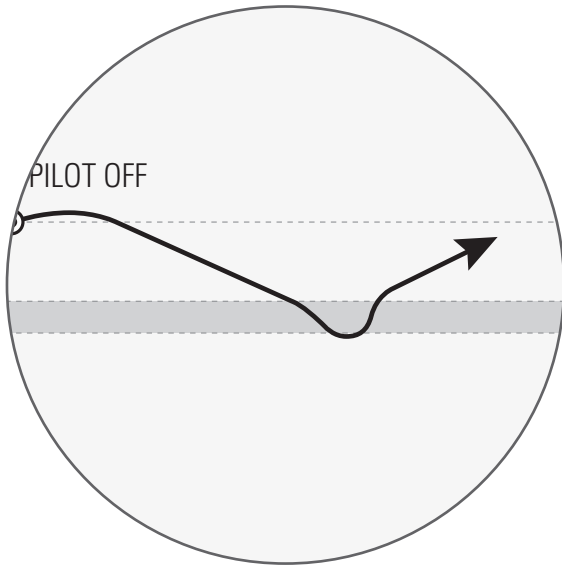

### 3.4.5 Proportional Valve Control

The main valve safety solenoid is opened using the main valve output, but there is a second variable output control valve in series which is controlled by the 4-20 mA control signal from the Profire 2100.

In this mode both the “High Fire” and “Low Fire” setpoints are enabled. If the temperature is below the “High Fire” setpoint, the 4-20 mA output slowly ramps up opening the control valve. When the temperature exceeds the “High Fire” setpoint, but is below the “Low Fire” setpoint, the 4-20 mA output decreases, closing the control valve. The burner should stabilize at the High Fire setpoint with the 4-20 control output controlling the temperature so the temperature is always slightly above or below the High Fire setpoint.

The ringing (swing) on the graph is caused by the balancing of temperature throughout the bath.

<b>EXAMPLE SETTINGS</b>	<b>°C</b>	<b>°F</b>
High Fire Setpoint	50	122
Low Fire Setpoint	60	140
Pilot Off Setpoint	DIS	DIS
Process High ESD Setpoint	100	212
Low Alarm Setpoint	10	50
Dead Band	4	7

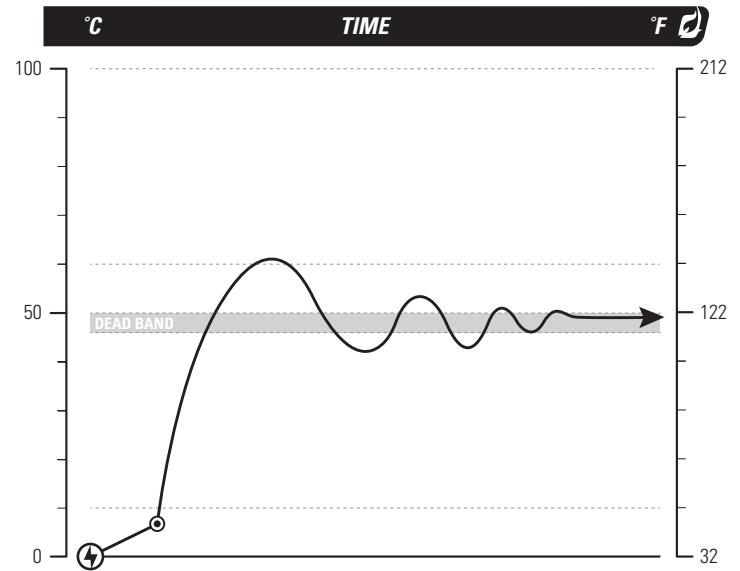

## 4.1 Normal Operation

<b>SYSTEM STATUS</b>	<b>RESPONSE</b>
System off and there is a flame	The system is in Power Save mode. Press any button to wake.
System off and there is no flame	The system is in Power Save mode. Press any button to wake. If still no response, check power.
Ready	Unit is in manual mode <ul style="list-style-type: none"> <li>• Press MODE button to return unit to AUTO mode</li> </ul>

## 4.2 Typical I/O Readings

<b>CONNECTION</b>	<b>EQUIPMENT</b>	<b>CONDITION</b>	<b>EXPECTED READING</b>
Thermocouple Inputs <ul style="list-style-type: none"> <li>• High Temp</li> <li>• Process</li> <li>• AUX</li> </ul>	Volt Meter with mV range: Set to measure DC voltage	System powered up no thermocouple connected	TC+ terminal should read approximately 140mVDC with reference to ground. TC- Terminal should read 70mVDC with reference to ground.
		System powered up with thermocouple connected	Both terminals should read approximately 110mV with reference to ground.
Contact Inputs <ul style="list-style-type: none"> <li>• Start</li> <li>• ESD</li> <li>• PoC</li> <li>• High Pressure</li> <li>• Low Pressure</li> <li>• Level</li> </ul>	Volt Meter: Set to measure DC voltage	System powered up with switch open	The meter should read approximately 8VDC between the “+” and “-” inputs.
		System powered up with switch closed	Both “+” and “-” terminal should read 0VDC with reference to ground.

4.2 Typical I/O Readings Continued...

CONNECTION	EQUIPMENT	CONDITION	EXPECTED READING 
Ion+  (Ion- is internally connected to ground)	Volt Meter: Set to measure AC voltage	System powered up with flame rod connected. No flame present	Ion+ should measure between 12VAC and 65VAC with reference to Ion- (ground).
	Volt Meter: Set to measure DC voltage		Ion+ should measure approximately 5VDC with reference to Ion- (ground).
	Volt Meter: Set to measure DC voltage	System powered up with flame rod connected. Flame present	Ion+ should drop from the 5VDC measured with no flame and cross below ground. With a good flame it should read -2VDC to -5VDC.
			<b>NOTE:</b> If your meter cannot read negative voltages then reverse the leads and put the positive lead on Ion- (ground) and look for a reading of 2VDC to 5VDC.
Coil + and -	Volt Meter: Set to measure DC voltage	System powered up with coil disconnected	The Coil+ terminal is disconnected from power when not sparking. When sparking it is pulsed on for a couple of milliseconds, turned off again, then repeated.  The Coil + terminal should measure 0VDC with reference to Coil- (ground).
	Multi-Meter: Set to measure resistance	System powered down with coil disconnected	The resistance should measure in the MΩ range or may read OL (out of range) on your meter.
	Multi-Meter: Set to measure resistance	System powered down with coil connected	The resistance between the Coil + and Coil- (ground) should be very low, in the 1Ω to 5Ω range.

#### 4.2 Typical I/O Readings Continued...

CONNECTION	EQUIPMENT	CONDITION	EXPECTED READING
Solenoid outputs • High Fire/Main • Low Fire • Pilot	Volt Meter: Set to measure DC voltage	System powered up. Solenoid outputs off	Both the “+” and “-” terminals of the coil are switched so no power or ground connection should be present. Both terminals should measure 0VDC.
	Volt Meter: Set to measure continuity	System powered up. Solenoid outputs off	Both the “+” and “-” terminals should measure open circuit

### 4.3 Error Messages

When there is more than one alarm, the abbreviated on-screen display will be shown. When a shutdown occurs, the system will enter a “lock-out” state with all outputs off. Selecting the “OK” button, toggling the “Start” contacts, or a power cycle, will be required to clear any of the following errors once the problem has been corrected.

ON SCREEN	DESCRIPTION	CAUSE	CORRECTIVE ACTION
Proc Thermocouple Error Or Proc TC	Thermocouple error	Process thermocouple is open or value is out of range	<ul style="list-style-type: none"> <li>• Check thermocouple wiring</li> <li>• Replace thermocouple</li> </ul>
HH Thermocouple Error Or ProHTC	Thermocouple error	High Temp thermocouple is open or value is out of range	<ul style="list-style-type: none"> <li>• Check thermocouple wiring</li> <li>• Replace thermocouple</li> </ul>
Aux Thermocouple Error Or Aux TC	Thermocouple error	AUX thermocouple is open or value is out of range	<ul style="list-style-type: none"> <li>• Check thermocouple wiring</li> <li>• Replace thermocouple</li> </ul>

#### 4.3 Error Messages Continued...

<b>ON SCREEN</b>	<b>DESCRIPTION</b>	<b>CAUSE</b>	<b>CORRECTIVE ACTION</b>
ESD Input Or ESD Inp	Emergency Shut Down	ESD input open	<ul style="list-style-type: none"> <li>• Check contact</li> </ul>
Flame Fail Or Flame	Flame Fail	Pilot not detected, retry limit expired	<ul style="list-style-type: none"> <li>• Check fuel, air &amp; ignition</li> <li>• Return to auto mode and try again</li> <li>• Check flame detection during ignition trial</li> </ul>
Proof Of Closure Open Or POC Inp	Proof of Closure input is open	Proof of Closure contacts open before main energized	<ul style="list-style-type: none"> <li>• Check wiring</li> <li>• Jumper contacts if no proof of closure is present</li> </ul>
Start Input Open Or St Inp	Remote Start input is open	Start contacts open	<ul style="list-style-type: none"> <li>• Close START contacts</li> <li>• Check wiring</li> </ul>
High Pressure Or HighPR	High Pressure Switch open	High Pressure switch input open	<ul style="list-style-type: none"> <li>• Check pressure switch wiring</li> <li>• Check fuel pressure</li> <li>• Check wiring</li> </ul>
Low Pressure Or LowPR	Low Pressure Switch open	Low Pressure switch input open	<ul style="list-style-type: none"> <li>• Check pressure switch wiring</li> <li>• Check fuel pressure</li> <li>• Check wiring</li> </ul>
Level Input Or Lvl Inp	Level switch open	Level switch has opened	<ul style="list-style-type: none"> <li>• Check level switch wiring</li> <li>• Check bath level</li> <li>• Check wiring</li> </ul>
High Temp Or Hi Temp	High Temperature Shutdown	Process or High Temp thermocouple has reached the High Temp ESD setpoint	<ul style="list-style-type: none"> <li>• Verify setpoints</li> <li>• Allow bath to cool</li> <li>• Calibrate Process and High Temp</li> </ul>

#### 4.3 Error Messages Continued...

<b>ON SCREEN</b>	<b>DESCRIPTION</b>	<b>CAUSE</b>	<b>CORRECTIVE ACTION</b>
AUX High Temp Or AUX HT	High Temperature Shutdown	AUX thermocouple is confirmed for High Temp ESD and has reached the AUX setpoint	<ul style="list-style-type: none"> <li>• Calibrate AUX Thermocouple</li> <li>• Allow the AUX to cool</li> <li>• Verify setpoints</li> </ul>
High Voltage Or Hi Volt	High Voltage	Voltage input to the board is too high	<ul style="list-style-type: none"> <li>• Reduce the input voltage</li> <li>• If the system is running off of 2V, ensure that the system setting is correct in menu 4</li> </ul>
Low Voltage Or Lo Volt	Low Voltage	Voltage input to the board is too low	<ul style="list-style-type: none"> <li>• Increase the input voltage</li> <li>• If the system is running off of 24V, ensure that the system setting is correct in menu 4</li> </ul>
Flame Detected Before Start	Flame detected before start	Flame detected when trying to ignite the burner	<ul style="list-style-type: none"> <li>• Ensure valves are closed</li> <li>• If the distance from the pilot valve to the nozzle is long then try increasing the purge time</li> <li>• Check for other sources of flame</li> </ul>
Unit Stopped Via Start Input	Start contacts open	Remote start has been opened	<ul style="list-style-type: none"> <li>• Check wiring</li> </ul>
Solenoid Feedback Error	Solenoid power error	A solenoid output is detected as being on when it should be off, or off when it should be on	<ul style="list-style-type: none"> <li>• Check for shorted outputs</li> <li>• Check solenoid wiring</li> </ul>
Master Power not Detected	Master power error	Master power switch is not turning on, or is on when it should be off	<ul style="list-style-type: none"> <li>• Check for shorted outputs</li> </ul>
Error xx Or Sys Err	Internal system error	Internal error detected in the system	<ul style="list-style-type: none"> <li>• Reset both boards or cycle power</li> <li>• Replace terminal card</li> </ul>
EEPROM Error	Internal system error	The Door Card micro cannot communicate with the EEPROM or there was a CRC error in the EEPROM	<ul style="list-style-type: none"> <li>• Reset the Door Card or cycle power</li> <li>• Replace the door card</li> </ul>

4.3 Error Messages Continued...

<b>ON SCREEN</b>	<b>DESCRIPTION</b>	<b>CAUSE</b>	<b>CORRECTIVE ACTION</b> 
Pilot Timeout	Key held	Pilot button held down for more than 30 seconds	<ul style="list-style-type: none"> <li>• Do not hold the pilot button for &gt; 30 seconds</li> <li>• Replace the door card</li> <li>• Check for a stuck key by running the following key test: Hold <math>\Delta</math> and <math>\nabla</math> buttons, then press MAIN to run the test</li> </ul>
Spark Timeout	Key held	Ignite button held down for more than 30 seconds	<ul style="list-style-type: none"> <li>• Do not hold the pilot button for &gt; 30 seconds</li> <li>• Replace the door card</li> <li>• Check for a stuck key by running the following key test: Hold <math>\Delta</math> and <math>\nabla</math> buttons, then press MAIN to run the test</li> </ul>
Flame Test	Internal System Error	Fault in the flame detection circuit.	<ul style="list-style-type: none"> <li>• Move the flame rod further into the flame</li> <li>• Check the grounding from the pilot nozzle to the PF2100</li> <li>• Replace the ribbon cable</li> <li>• Replace terminal card</li> </ul>
TCs Not Equal	Thermocouple error	The High Temp Thermocouple reading on the door and terminal cards is not the same, or "High Temp" and "Process" readings are greater than 10°C (50°F) apart. The three temperatures will be shown. DC High Temp, TC High Temp, Proc Temp	<ul style="list-style-type: none"> <li>• Reset both, or cycle power</li> <li>• Check the thermocouple wiring</li> <li>• Verify that the "Process" and "High Temp" thermocouples are reading the same temperature</li> </ul>
Ambient Temps Not Equal	Internal System Error	The ambient (cold injunction) temperature as read on the door card and terminal card are more than 10°C (50°F) apart	<ul style="list-style-type: none"> <li>• Verify the thermocouple wiring</li> <li>• Calibrate the thermocouples</li> </ul>

#### 4.3 Error Messages Continued...

<b>ON SCREEN</b>	<b>DESCRIPTION</b>	<b>CAUSE</b>	<b>CORRECTIVE ACTION</b>
Control Error	Internal System Error	Error in the control system	<ul style="list-style-type: none"> <li>• Reset or cycle power</li> <li>• Replace the door card</li> </ul>
Key Stuck Error "Key name"	Keypad problem	Key shorted at startup	<ul style="list-style-type: none"> <li>• Reset or cycle power</li> <li>• Inspect ribbon cable connection</li> <li>• Replace the keypad</li> </ul>
Stopped	Stopped	The stop key has been pressed	<ul style="list-style-type: none"> <li>• Press OK key</li> </ul>
Comparison "error"	Internal System Error		<ul style="list-style-type: none"> <li>• Reset or cycle power</li> <li>• Reverse ribbon</li> <li>• Replace the ribbon cable</li> <li>• Replace terminal</li> </ul>
Terminal Card Communications	Communication error	Communication error between the door card and terminal card	<ul style="list-style-type: none"> <li>• Reset or cycle power</li> <li>• Check ribbon cable connection</li> <li>• Reverse ribbon</li> <li>• Replace ribbon</li> <li>• Replace the terminal card</li> </ul>
Terminal Card Command Refused	Internal system error	The terminal card has rejected a command sent by the door card	<ul style="list-style-type: none"> <li>• Check the solenoid wiring, if there are crossed wires or if a common wire is used for the negative return this error can result.</li> <li>• Reset or cycle power</li> <li>• Reverse ribbon</li> <li>• Replace the ribbon cable</li> <li>• Replace one or both cards</li> </ul>
Terminal Card Output Feedback	Solenoid power error	A solenoid output is detected as being on when it should be off, or off when it should be on	<ul style="list-style-type: none"> <li>• Reset or cycle power</li> <li>• Check for shorted outputs</li> </ul>

4.3 Error Messages Continued...

<b>ON SCREEN</b>	<b>DESCRIPTION</b>	<b>CAUSE</b>	<b>CORRECTIVE ACTION</b> 
Terminal Card Reciprocal Comp	Internal system error	The reciprocal comparison between the cards does not agree	<ul style="list-style-type: none"> <li>• Reset or cycle power</li> <li>• Reverse ribbon</li> <li>• Replace the ribbon cable</li> <li>• Replace one or both cards</li> </ul>
Terminal Card Shutdown Detect	External system error	Contact input detected open by the terminal card: ESD, High Pressure, Low Pressure, Level	<ul style="list-style-type: none"> <li>• Reset or cycle power</li> <li>• Check wiring</li> <li>• Reverse ribbon</li> <li>• Replace the ribbon cable</li> </ul>
Terminal Card Invalid Command	Internal system error	The terminal card has received an invalid command from the door card.	<ul style="list-style-type: none"> <li>• Reset or cycle power</li> <li>• Reverse ribbon</li> <li>• Replace the ribbon cable</li> <li>• Replace the door card</li> </ul>
Terminal Card High Temp Alarm	High Temperature Shutdown	Process or High Temp Thermocouple has reached the High Temp ESD setpoint. This is detected by the terminal card first.	<ul style="list-style-type: none"> <li>• Reset or cycle power</li> <li>• Allow bath to cool</li> </ul>
Terminal Card HHTC Grounded	Thermocouple error	High Temp Thermocouple is shorted to ground.	<ul style="list-style-type: none"> <li>• Check for wiring faults with the thermocouples</li> <li>• Check for a short to ground on the high temp thermocouple.</li> </ul>

## 4.4 Calibration

Factory calibration has been performed.

<b>ON SCREEN</b>	<b>DESCRIPTION</b>	<b>FUNCTION</b>	<b>RANGE</b>	<b>DEFAULT SETTING</b>	<b>USER SETTING</b>
Cal: Proc TC Zero = No	Process thermocouple zero calibration	Short the Proc "+" and "-" contacts and select Yes	N/A	N/A	
Cal: ProcH TC Zero = No	High Temp thermocouple zero calibration	Short the ProH "+" and "-" contacts and select Yes	N/A	N/A	
Cal: AUX TC Disabled	AUX thermocouple zero calibration	Short the AUX "+" and "-" contacts and select Yes	N/A	N/A	
Cal: Proc TC = xxC	Process thermocouple span calibration	Provide a calibrated 212°F signal (from thermocouple in a block or meter) to the Process TC input and adjust the reading to match the applied temperature.	N/A	N/A	
Cal: High Temp TC = xxC	High Temperature thermocouple calibration	Provide a calibrated 212°F signal (from thermocouple in a block or meter) to the High Temp TC input and adjust the reading to match the applied temperature.	N/A	N/A	
Cal: AUX TC = xxC	AUX thermocouple calibration	Provide a calibrated 212°F signal (from thermocouple in a block or meter) to the AUX TC input and adjust the reading to match the applied temperature.	N/A	N/A	

<b>ON SCREEN</b>	<b>DESCRIPTION</b>	<b>FUNCTION</b>	<b>RANGE</b>	<b>DEFAULT SETTING</b>	<b>USER SETTING</b>
Cal: 4-20 Low Adj for 4mA	Calibration for 4mA output	Insert a current meter inline with the 4-20mA output and use the $\Delta$ and $\nabla$ keys to adjust the output until the current meter reads 4mA.	N/A	N/A	
Cal: 4-20 High Adj for 20mA	Calibration for 20mA output	Insert a current meter inline with the 4-20mA output and use the $\Delta$ and $\nabla$ keys to adjust the output until the current meter reads 20mA.	N/A	N/A	

# 4.5 Flame Detection Troubleshooting

System is not detecting flame.

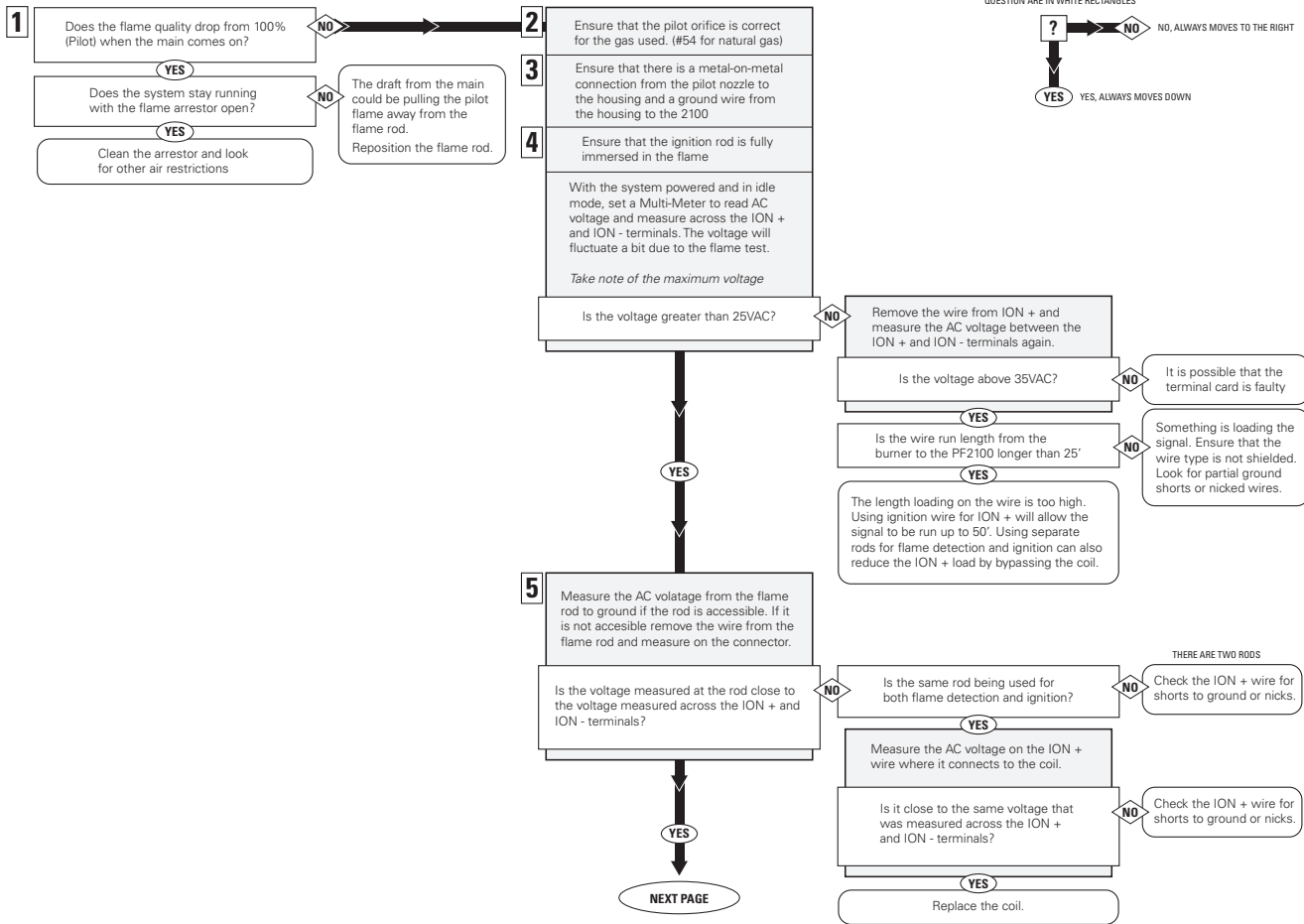

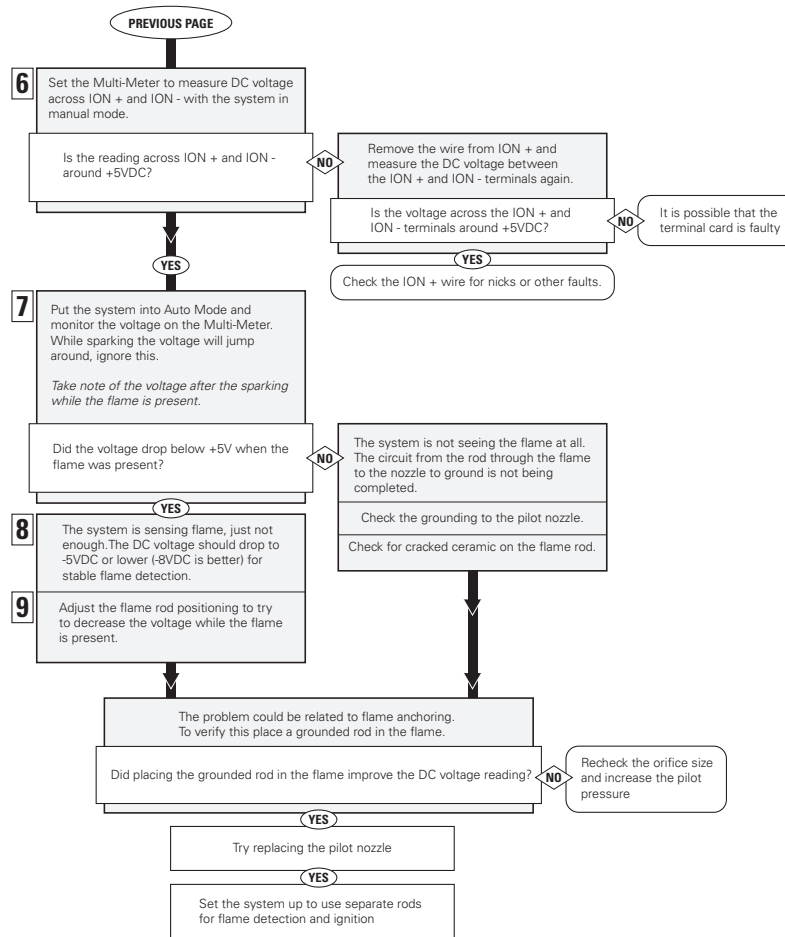

# 4.6 Thermocouple Troubleshooting

Problem with Thermocouples.

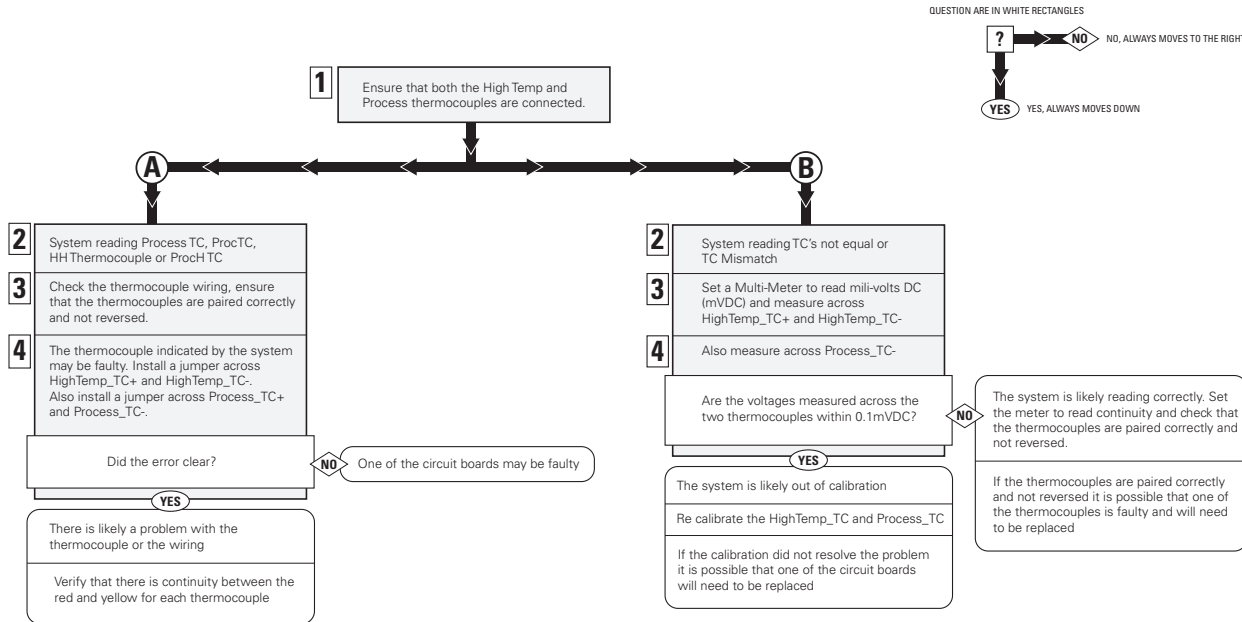





[WWW.PROFIREENERGY.COM](http://WWW.PROFIREENERGY.COM)  
© 2011 PROFIRE